



Adsorption of Nitrogen from Air to Produce Oxygen

Marwa Hussein Mohammed Ali ^a, Raghad F. Almilly ^a and Riyadh K. Abid ^b



CrossMark

^aChemical Engineering Department - University of Baghdad – Baghdad – Iraq

^bPetroleum and Petrochemical Research Centre- Ministry of Science and Technology (MoST)-Iraq.

Abstract

In our current life, a severe challenge is faced with a lack of synthetic oxygen because of infection with the Coronavirus. Oxygen can be supplied by using selective adsorption of nitrogen from the air using Pressure-Vacuum Swing Adsorption (PVSA). The experimental layout consists of one column (inner diameter 4 cm) packed with commercial Li⁺ cation loaded on the zeolite low silica type x (Li-LSX zeolite), the particle size of zeolite is 0.4–0.8 mm of 9 cm in height. The effects of inlet air pressure 0.5–2.5 bar and inlet air flow rate 2–10 L min⁻¹ on outlet oxygen purity and recovery were studied. Also, the isotherm behavior was studied to determine the type of adsorption. The results showed that increasing inlet pressure and flow rate increased the amount of adsorbed nitrogen, i.e., increased oxygen purity in the outlet. The effect of pressure tended to reduce the adsorption over a certain limit 2.5 bar due to forcing gas molecules to enter the sites on the zeolite particles' surfaces. Optimization was observed (73.14 % purity, 2.4496 recovery, and 153.471 mmolKg⁻¹s⁻¹) with productivity of oxygen at 2.5 bar and 8 L min⁻¹. Also, the adsorption isotherm and breakthrough curve were studied.

Keywords: Coronavirus, Pressure-Vacuum Swing Adsorption (PVSA), Li-LSX zeolite, Pressure, Flow rate, adsorption isotherm, breakthrough curve

1. Introduction

As a result of the current COVID-19 pandemic outbreak, the need for portable medical oxygen has skyrocketed [1]. COVID-19, chronic obstructive pulmonary disease (COPD), chronic bronchitis, and pneumonia all require medical oxygen concentrators (MOCs) to prevent hypoxemia-related consequences [1-3]. All people should have oxygen therapy, according to the World Health Organization [1]. Air is separated into its constituents using three basic technologies [4]: adsorption, membranes, and cryogenic separation. The usefulness of each of these technologies is frequently determined by the volume of separation products required [5-6]. When it is important to create high purity oxygen, the adsorption separation method [7] is used. Numerous medical oxygen equipment has been designed based on it [2]. The difference in sorption capabilities for the components is used to separate the components by adsorption [8]. N₂-selective adsorbents are used to produce oxygen from ambient air [2] in pressure swing, vacuum swing, or pressure-vacuum swing adsorption processes (PVSA) [9-10]. When compared to the TSA process cycle, the PSA process has a typical total cycle time of one to several seconds,

compared to the TSA method's cycle length of hours. The most prevalent technique is pressure swing adsorption (PSA) [2]. Due to the interaction of guest gas molecules' dipole and quadrupole moments with additional frame cations of zeolites, zeolites are utilized for air separation. In a combination with O₂, the Li form of LSX zeolite has a substantially better adsorption capacity and selectivity of N₂ [11-12]. The feasibility of any packing material used to adsorb N₂ to produce pure O₂ can be determined by estimating the productivity, which is defined by equation 1 [8]:

$$\text{Productivity} = \frac{\text{Moles of O}_2}{(\text{time} \times \text{adsorbent mass})} \quad (1)$$

This function is related to the total cost, the fixed cost through the adsorbent material, and the operating cost through the time of production. Recovery is another function of the method of O₂ production by estimating the produced O₂ as a ratio to the feed, which is defined by equation 2 [8]:

$$\text{Recovery} = \frac{\text{moles of O}_2 \text{ produced}}{\text{moles of O}_2 \text{ in the feed}} \quad (2)$$

Adsorption isotherm models were proposed by Langmuir, Freundlich, and others [13-14]. Langmuir adsorption, which was developed to characterize gas-solid phase adsorption was used to compare and

*Corresponding author e-mail: marwa.ali1607m@coeng.uobaghdad.edu.iq; (Mohammed Ali).

Receive Date: 23 July 2022, Revise Date: 06 August 2022, , Accept Date: 29 August 2022,

First Publish Date: 28 February 2023

DOI: 10.21608/EJCHEM.2022.151956.6578

©2022 National Information and Documentation Center (NIDOC)

measure the adsorptive capacity of different adsorbents [15]. Langmuir isotherm balances the relative adsorption and desorption rates to account for surface coverage (dynamic equilibrium). While adsorption is proportional to the open fraction of the adsorbent surface, desorption is proportional to the covered fraction of the adsorbent surface [16]. One of the linear representations of the Langmuir equation was applied in the present study which is [17-19]:

$$\frac{q_e}{C_e} = K_a q_m - K_a q_e \quad (3)$$

where:

C_e = the equilibrium concentration of adsorbate (mgL^{-1}). q_e = the amount of adsorbate adsorbed per gram of the adsorbent at equilibrium (mgg^{-1}). q_m = maximum monolayer coverage capacity (mg g^{-1}). K_a = Langmuir isotherm constant (Lmg^{-1}).

2. Experimental

2.1 Material.

Li-LSX Zeolite from China was used in the experiments. The technical specification of this zeolite is listed in Table 1.

2.2 Equipment

An experimental setup is shown in Figure 1. All the equipment used are listed in Table 2.

2.3 Procedure

To avoid moisture and impurities, it must first heat the adsorbent (Li-LSX zeolite) for 45 minutes before starting the procedure of any experiment. The air compressor was turned on until the tank pressure reaches the desired level, after which air was injected into the air collection cylinder to maintain air stability, and finally, the air was blown through a silica gel-filled filter to remove moisture and pollutants [15]. Set the flow meter to the required flow. Air enters the column filled with zeolite from the bottom to adsorb nitrogen on its surface and exit the oxygen-rich gas from the top. The oxygen product was split into two streams: one for the pressure gauge (PG 3) and flow meter (FM 3) purge stream, and the rest for the pressure gauge (PG 2) and flow meter (FM 2) purge stream. After each cycle, it must vacuum the adsorbent at - 0.9 bar for 2 minutes to get it ready for removing N_2 gas molecules from the zeolite surface.

Table 1: The technical specification of Li-LSX zeolite (Commercial name JLOX-101).

Property	Unit	JLOX-101
Diameter	mm	0.4 – 0.8
N_2 Adsorption capacity	mlg^{-1}	≥ 22
N_2/O_2 Selectivity	~	≥ 6.20
Crush strength	N	~
Bulk density	gml^{-1}	0.63 ± 0.03
Moisture content	wt%	≤ 0.5
Particle ratio	%	≥ 95

Table 2. Equipment used in the research.

No	Device	Specification	Range	Country
1	Air compressor	ingco industrial 220-240V, ~50Hz, AC25508	0-8 bar	China
2	Pressure gauge with filter unit	Filter unit D = 2.5 cm L = 5 cm	Pressure gauge 0-10 bar	China
3	Feed flow meter	PMB CV.P. A10.LM. G2	1-10 Lmin^{-1}	China
4	Adsorption column	class type QVF L= 17 cm id= 4 cm		
5	Product pressure gauge		0-3 bar	China
6	product flow meter	PMB CV.P. A10.LM. G2	1-10 Lmin^{-1}	China
7	O_2 gas sensor	GDX- O_2 , L = 15.5 cm D = 2.8 cm	0-100% O_2	U. S.
8	purge flow meter	Matheson U310	0.5 - 6 Lmin^{-1}	China
9	valves			China
10	Drum	L = 60 cm D = 37 cm	V=6448 cm^3	

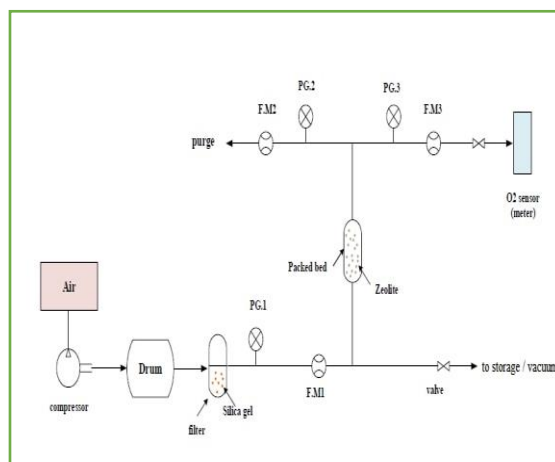

Fig. 1: Schematic of experiment system.

3. Results and Discussions

PVSA Study

Different pressures and flow rates were used for the PVSA study. Figure 3 shows how the amount of O_2 gas in the air changes over time for different air pressures at the flow rate of 8 Lmin^{-1} . The amount of nitrogen in a 100 percent air mixture was calculated by the difference. At 0.5 bar, O_2 gas percentage increases in the outlet stream and it was only from 21 % at zero sec to 30 % at 120 sec. This indicates low N_2 capture on the zeolite surface. This was attributed to low pressure. Gases tend to be attracted to solid surfaces, or "adsorbed" at high pressures [15].

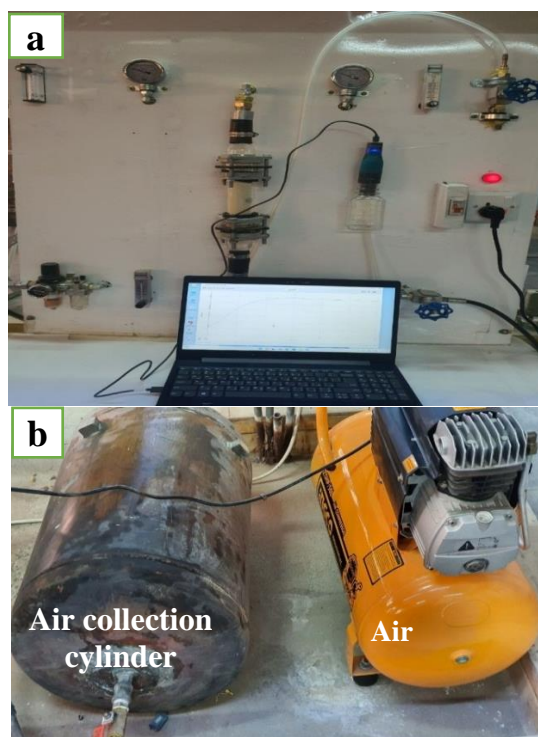

Fig. 2: Complete view of the real system to produce oxygen gas (a) Experimental setup. (b) Air compressor and Air collection cylinder.

Thus, the higher the pressure, the more N_2 gas is adsorbed. This fact can be recognized in the successive pressure curves. The curves at 1 and 1.5 bar show an observed increase in the O_2 gas % with the increase in the pressure at 120 sec: 49 % and 50 % respectively. At 2 and 2.5 bar further increase in O_2 gas % occurred due to the increase in the pressure. According to these observations, 2.5 bar represents the best pressure to produce the optimum volume percentage of oxygen under these conditions Figure 3. Figure 4 shows the amounts of existing nitrogen in the air stream as volume percent at a time in the duration of the experiment for different pressures. It was noticed that nitrogen volume percent decreased steadily due to its adsorbing on the zeolite surface as far as, when the pressure is increased, the amount of nitrogen adsorbed also increases. Figure 5 shows the error bars based on standard errors for the amounts of oxygen and nitrogen gases percentage respectively. Figure 6 shows that O_2 gas volume percent increased directly with increasing flow rate. This was attributed to the increase in the molecules of both gases (O_2 and N_2) which increases the driving force for N_2 gas adsorption and increases O_2 gas in the outlet. It was noticed that there was an unstable increase at high flow rates, i.e., 6, 8, and 10 $L\ min^{-1}$. This is because of high turbulence at these flow rates, which led to renewable eddies of gas in contact with the zeolite surface, enhancing mass transfer and N_2 gas adsorption. In case renewable eddies of N_2 gas faced saturated sites on the solid with previously adsorbed N_2 gas molecules, the eddies would leave the

column without being adsorbed so N_2 concentration increased in the outlet. Figure 7 shows the productivity of O_2 gas as a function of pressure. The curve in figure 7 shows that the production of pure oxygen from air depended mainly on the inlet pressure. As far as the pressure increased, the productivity of oxygen increased for a certain mass of packing. This indicates that increasing the operating costs will be only with the fixed cost unchanged. Here is an issue of optimization between increasing the pressure or increasing the packing mass that needs to study. Figure 8 shows the recovery of O_2 gas as a function of inlet pressure. The recovery was acceptable within the range of study and the adsorption method seemed feasible.

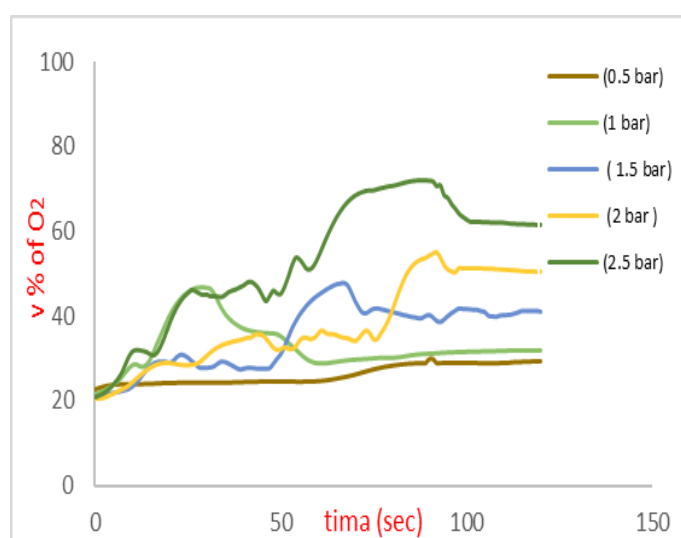

Fig. 3: volume percentage of O_2 gas at flow rate of 8 $L\min^{-1}$ and different pressures.

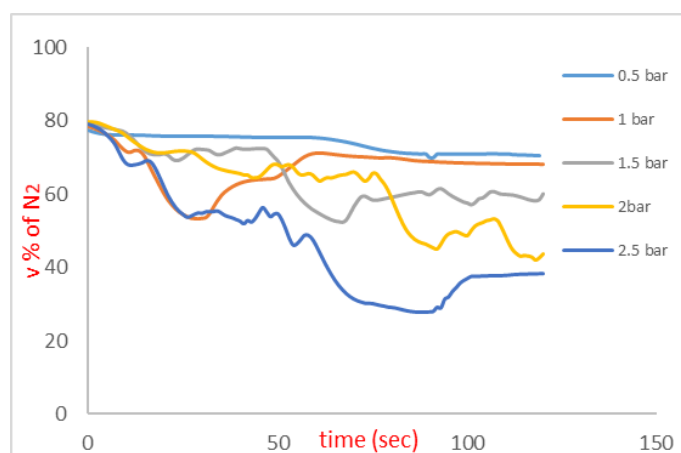

Fig 4: Volume percentage of N_2 gas at flow rate 8 $L\min^{-1}$ and different pressure.

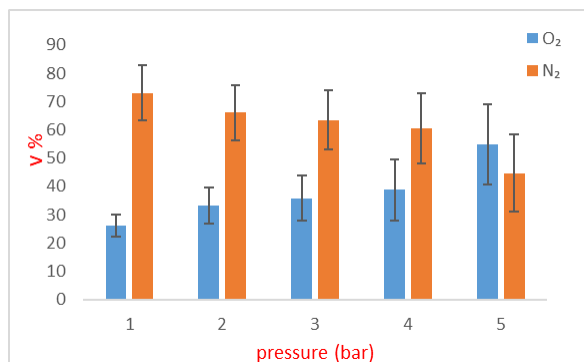

Fig5: Error bars of volume percentage of O₂ and N₂ gas at different pressure 0.5 bar, 1 bar, 1.5 bar, 2 bar, 2.5 bar

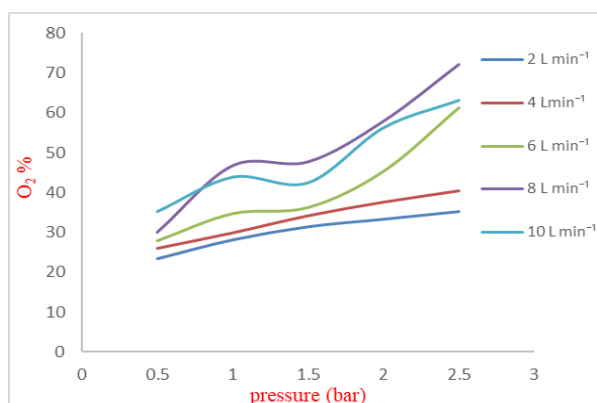

Figure 6: Oxygen gas purity % as a function of inlet air pressure for different inlet flow rates

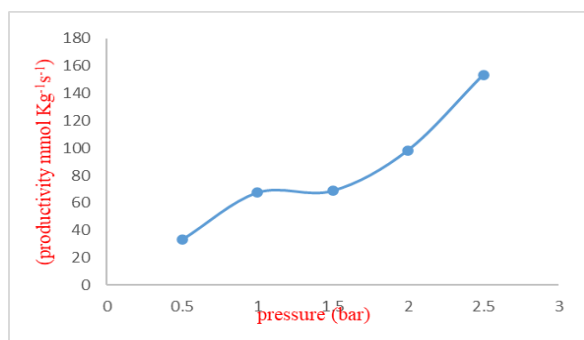

Fig7: Feed pressure effect on Productivity.

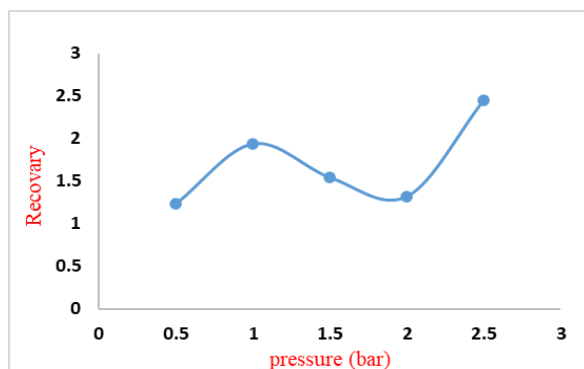

Fig.8: Feed pressure effect on Recovery.

4- Isotherm models

Langmuir isotherm fitted well the experimental data as shown in Fig. 11 where $R^2 = 0.9042$. This indicates that the adsorption of N₂ on the zeolite was physical and homogeneous. This agrees with the previous studies [1-8]. By comparison between the resulted equation from the graph with the equation 3, the slope and the intercept were determined as $K_a = -0.0137 \text{ Lmg}^{-1}$ and $q_m = 0.029 \text{ mgg}^{-1}$, respectively. K_a indicated the constant of Langmuir equation and q_m indicated the maximum capacity of the solid surface for adsorption.

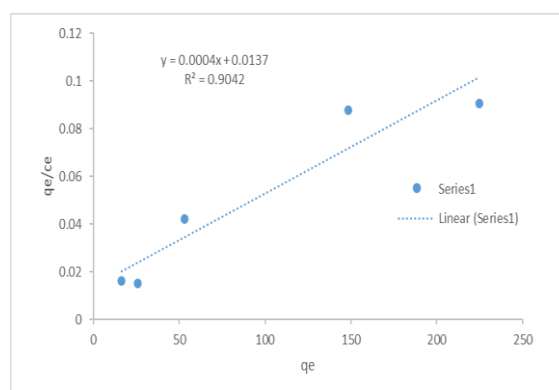

Fig.9: Langmuir Isotherm Model.

5-Conclusion

Screening an adsorbent for a medical oxygen concentrator based on the adsorption separation was crucial for PVSA separation performance. The adsorption properties of Li-LSX zeolites were useful to use this adsorbent in the production of O₂ gas by the adsorption method. The operation depended mainly on pressure. As far as the pressure increases the production of O₂ gas increases. Increasing the flow rate enhanced the adsorption by increasing mass transfer via renewable eddies. The optimum-operating conditions within the range of study were 2.5 bar pressure and 8 Lmin⁻¹ flow rate.

6- References

- [1] Akhil Arora & m. M. Afrique HASAN. Scientific reports. Flexible oxygen concentrators for medical applications. (2021) 11:14317.
- [2] Qadir, defy li, yiming, Zhongshan yuan, yu jun Zhao, sheng wang, and shading wang. Industrial & engineering chemistry research. Experimental and numerical analysis on the enhanced separation performance of a medical oxygen concentrator through two-bed rapid pressure swing adsorption Salman. (2021); 60: 5903–5913.
- [3] RAMA Rao vemula·Matthew d. Ulrich ·mayu resh v. Kothare. adsorption journal, Experimental design of a “Snap-On”

- and standalone single-bed oxygen concentrator for medical applications (2021).
- [4] Ivanova, E.N., Averin, A.A., Alekhina, M.B., Sokolova, N.P. and Kon'kova, T.V. *Protection of Metals and Physical Chemistry of Surfaces* Thermal Activation of Type X Zeolites in the Presence of Carbon Dioxide. 2016, 52(2), pp.267-272.
- [5] Tishin, A.A. and Gurkin, V.N. In *Journal of Physics: Conference*, Development of a mathematical model of molecular-selective gas transfer in a hybrid membrane-adsorption oxygen concentrator. 2019, November, Series (Vol. 1368, No. 4, p. 042043) IOP Publishing.
- [6] Ivanova, E.N., Averin, A.A., Alekhina, M.B., Sokolova, N.P. and Kon'kova, T.V. *Protection of Metals and Physical Chemistry of Surfaces*. Thermal Activation of Type X Zeolites in the Presence of Carbon Dioxide, 2016, 52(2), pp.267-272.
- [7] Tishin, A.A., *Petroleum Chemistry*. Study of Adsorption Properties of Zeolites NaX, CaA, a CaNaA in Separation of Air Components. 2020, 60(8), pp.964-970.
- [8] Akulinin, E.I., Gladyshev, N.F. and Dvoretzkii, S.I. *Gos. Tekh. Univ.* Advanced technologies and methods for creation of composite sorption-active materials for cyclic adsorption processes. *Vestn. Tambov.*, 2017, 23(1), pp.85-103.
- [9] Chao, c. C. U.s. patent Process for separating nitrogen from mixtures thereof with less polar substances, (1989) 4,859,217.
- [10] Yang, r. T. Wiley-Interscience, fundamentals and applications Sorbents for applications. Adsorbents; (2003).
- [11] Günay, e. Arslan kaya, and i. Tosun, ,” *Journal of hazardous materials*, “lead removal from aqueous solution by natural and pretreated clinoptilolite: adsorption equilibrium and kinetics. (2007) vol.146, no. 1-2, pp. 362–371.
- [12] Mahmoud A. M., Youssef N. A., Shaban S. A., and Selim M. M.,” *Egypt. J. Chem.*, “Synthesis of nano - nickel metal loaded on faujasite-zeolite for reduction of p-nitro phenol to p-amino phenol. 2018. vol. 61, no. 6, 2018, DOI: 10.21608/ejchem3844.1332.
- [13] T.m. Elmorsi,” *journal of environmental protection*, “equilibrium isotherms and kinetic studies of removal of methylene blue dye by adsorption onto miswak leaves as a natural adsorbent. (2011) vol 2, no. 6, pp. 817–827.
- [14] N. Ayawei, s. S. Angaye, d. Wankasi, and e. D. Dikio,” *open journal of physical chemistry*, “synthesis, characterization, and application of mg/al layered double hydroxide for the degradation of congo red in aqueous solution (2015), vol. 5, no. 03, pp. 56–70.
- [15] A. Günay, e. Arslankaya, and i. Tosun,” *Journal of hazardous materials*, “lead removal from aqueous solution by natural and clinoptilolite: adsorption equilibrium and kinetics, (2007) vol. 146, no. 1-2, pp. 362–371.
- [16] Dr. Hussein H. Hamed. Al-Qadisiyah *Journal for Engineering Sciences, Oxygen and Nitrogen Separation from Air Using Zeolite Type 5A*, (2015), 8(2): 147-158.
- [17] Mirjana M. Brdar, Aleksandar A. Takači, Marina B. Šćiban, Dušan Z. Rakić, *Hem. Ind.* Isotherms for the adsorption of Cu (II) onto lignin – comparison of linear and non-linear methods, (2012), 66 (4) 497–503.
- [18] N. J. Ali and K. H. Hassan, ” *Egypt. J. Chem.*, “Adsorption isotherms and thermodynamic study of cu (ii) and ni (ii) removal using commercial zinc oxide nanoparticle, 2022, vol. 65, no. 2, doi: 10.21608/EJCHEM.2021.85012.4144.
- [19] Ali R. T., N. Saeed H. M., and Al-Niemi K. I., *Egypt. J. Chem* “Study of Isothermal, Kinetic and Thermodynamic Parameters of Adsorption of Glycolic Acid by a Mixture of Adsorbent Substance with ab-Initio Calculations,” 2022, vol. 65, no. 6, doi: 10.21608/EJCHEM.2022.118101.5321.